



C R E A T I V E O U T D O O R G E A R

📍 : Rukan Niaga Boulevard Metland Menteng Blok i1 no.26, RT.1/RW.8, Ujung Menteng

☎ : (+62) 8195001099

2026 / 2027





WHO WE ARE

Wild Land is a company with 20 years of experience specializing in the design, development and production of outdoor equipment products. With strong capability of R & D, production and quality management, our main products are roof top tents, camping ground tents, outdoor leisure lights, outdoor furniture, outdoor cookware, sleeping bags etc.

Products innovation

Wildland is driven innovation and an unparalleled reputation for quality and value. These basic principles guide Wildland through the creation of innovative and highly popular designs.

Marketing strategies

At Wildland we strive to distinguish ourselves with creative, environment friendly products that provide our customers excellent value.

01	Wild Land Wingman X	40	Wild Land Shoe Bags	66	Wild Land Foldable Camping Hanging Rack
03	Wild Land Automatic Clear-Top Roof Tent	41	Wild Land Truck Bed Rack	67	Wild Land Integrated Kitchen Box Pro
05	Wild Land OrthFrame V2	42	Wild Land Truck Tower System	68	Wild Land Multi-function Outdoor Cookware
07	Wild Land Neo-Frontier	43	Wild Land Roof Rack System 2.0	69	Wild Land S14 String Light with speaker
09	Wild Land WL-Air Cruiser	45	Wild Land Privacy Tent	71	Wild Land Galaxy Solar Light
11	Wild Land Lite Cruiser 120XL Pro	46	Wild Land Cambox Shade	73	Wild Land Trackwalker Lantern
13	Wild Land Voyager Pro	47	Wild Land Cambox Shade Lux	75	Wild Land Thunder Lantern
15	Wild Land Desert Cruiser Family	48	Wild Land Hub Screen House 400 XL	77	Wild Land Mini Lantern
17	Wild Land Desert Cruiser V2 130	49	Wild Land Hub Screen House 600	79	Wild Land Ring Lantern
19	Wild Land Rock Cruiser Pro	50	Wild Land Hub Screen house 600 Lux	81	Wild Land Knight SE
21	Wild Land Pathfinder II Pro	51	Wild Land Star hub tent	83	Wild Land High Lumen Knight SE
23	Wild Land Wild Cruiser Pro	52	Wild Land MTS- Mini Table	85	Wild Land Hemp Rope Lantern
25	Wild Land Litestri	53	Wild Land MTS-X Chair	87	Wild Land High Lumen Jade
27	Wild Land Bush Cruiser V2 Pro	54	Wild Land MTS-X Table		
29	Wild Land Detachable Thermal Liner	55	Wild Land MTS-C Chair		
30	Wild Land Car Awning	56	Wild Land MTS-C Table Pro		
31	Wild Land Car Awning LW	57	Wild Land Picnic Pad		
33	Wild Land Annex	58	Wild Land Collapsible Storage box		
34	Wild Land Universal Tarp	59	Wild Land Envelope Sleeping Bag		
35	Wild Land Universal Connector	60	Wild Land Portable Bamboo Table		
37	Wild Land 270° Car Awning	61	Wild Land Canvas Lounge Pro		
39	Wild Land U Bracket Kit	62	Wild Land Portable Lounge		
39	Wild Land RTT Mounting Kit	63	Wild Land Air Pillow		
39	Wild Land Anti-Thief Lock System	64	Wild Land Air Mattress		
40	Wild Land Anti-condensation Mat	65	Wild Land Light Stand		

CONTENTS

Pickup Mate

Wild Land Wingman X



Wild Land Wingman X

- Retains pickup's cargo and off-road capabilities while unlocking SUV agility & RV comfort.
- Non-destructive mounted installation that does not damage the vehicle body.
- Expanded pickup bed space to enhance loading capacity.
- Fully automated setup and fold down of a double-layer camping space. Self-developed Electric Push Rod System + X-scissor structure: enables smooth automation, ensures stability, strength, durability.
- The transparent rooftop skylight is perfect for photographer, hunting and stargazing.

Modular intelligent lighting system:

- First level with lighting and charging; second level with additional lighting.
- USB ports on the second level for convenient device charging.
- High-quality stereo speaker units on both the first and second levels.

Four-fold safety protection: one-touch power cutoff / dual safety protection during lifting / dual-level safety design / voice safety alerts.

Product Name: Wild Land Wingman X

Installation Method: Non-destructive, quick installation and removal

Compatible Vehicles: All pickup trucks

Capacity: 2-3 people

Recommended Scenarios: Camping, fishing, family road trips, overlanding, and more

Included Components: Main tent × 1, Bracket × 1, Ladder × 1, Remote controls × 2, Cigarette lighter × 1, Tailgate cover × 1, Stabilizer × 1, Pegboard × 1, Folding table × 1, Lighting and Speaker

Reference Weight: 269kg (593lbs)

External Closed Dimensions: 1870 × 1580 × 705 mm (73 × 62 × 28 in)

Lower Level Internal Dimensions: 1500 × 1360 × 980 mm (59 × 53.5 × 38.5 in)

Upper Level Internal Dimensions: 2250 × 1460 × 1060 mm (88.6 × 57.5 × 41.7 in)

Tent Structure: Dual-layer interlaced design with independent lifting for each level

Setup Method: Remote-controlled automatic lifting

Skylight Dimensions: 690 × 625 mm (27 × 24 in)

Fabric: 190g polycotton PU 2000mm

Color: Covert Green + Black

Mattress: High density mattress with skin-friendly thermal cover



Accessories



Optional :

Automatic Lifting system

The Wingman X Quick-Mount uses powered lifting for a true "back-in and-go" system, Set up or break down solo in minutes





Wild Land Automatic Clear-Top Roof Tent

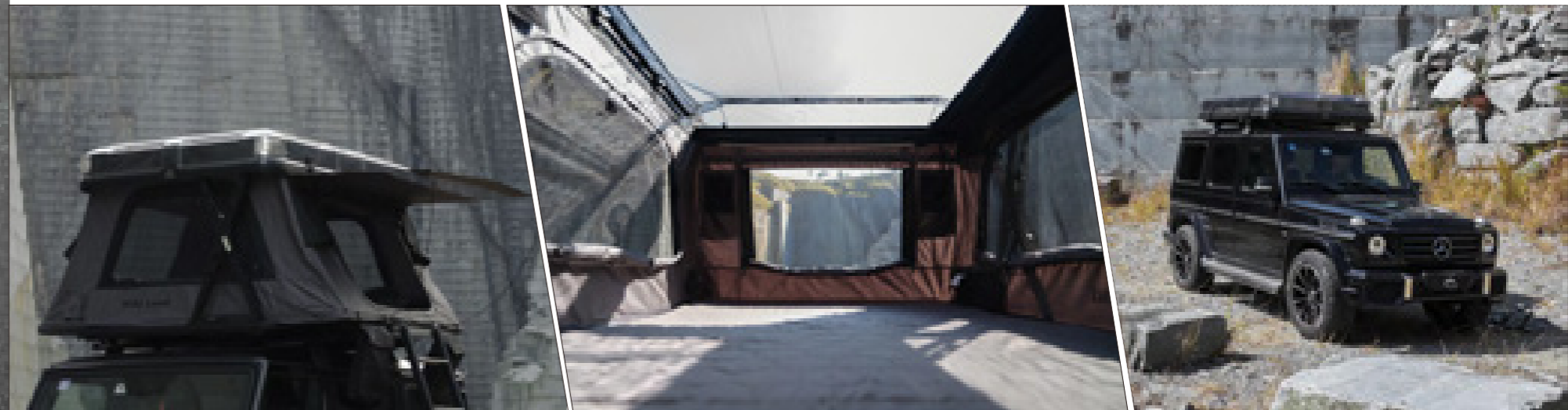

Wild Land Automatic Clear-Top Roof Tent

- The first trapezoidal folding Roof top tent in the world, compacter size, larger space.
- Transparent and aerodynamic hard shell for great sky view.
- Unique sliding curtain for privacy and light proof if needed.
- Dimmable LED strip and 5cm(2 in) high-density mattress with skin-friendly cover included.
- Panorama view with two big doors and massive windows.
- Specially suitable for SUV's and trucks.

Specification

Tent size: 215×145×100 cm(84.7×57.1×39.3 in)

Packing size: 184x154x40cm(72.4x60.6x15.8in) for tent
51x18.5x101cm(20.1x7.3x39.8in) for ladder

Close size: 174×143×37 cm(68.6×56.3×14.6 in)

Capacity: 2-3 persons

Net weight: 99kg(218.3lbs) for tent, 8kg(17.6lbs) for the ladder

Gross weight: 116kg(255.7lbs) for tent, 12.5(27.6lbs) for the ladder

Materials

Top shell: transparent PC, Anti-UV

Cover: 1000D transparent PVC Tarpaulin

Frame: Wireless remote control mechanism

Bottom: Fiberglass honeycomb plate

Fabric : 190g rip-stop polycotton PU2000mm

Mattress: Skin friendly thermal mattress cover with 4cm high-density foam mattress

Accessories



Wild Land OrthFrame V2

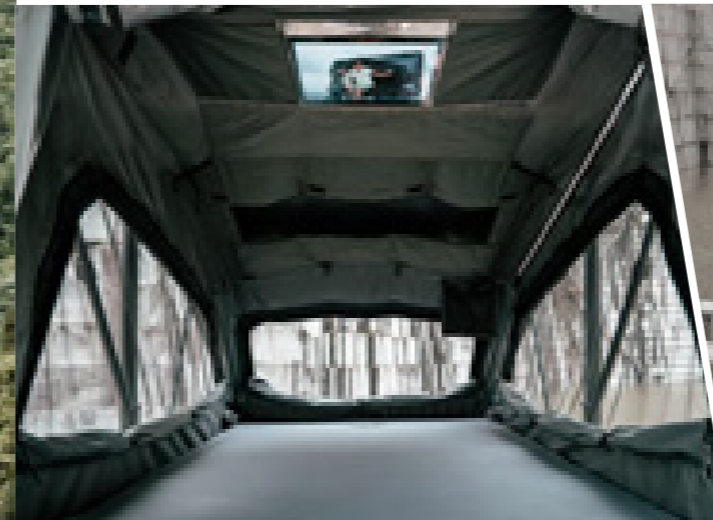

Wild Land OrthFrame V2

- Alloy hard shell but lightweight
- Folding design with compact packing size
- Large eave for great sun and rain protection
- Super comfortable foam mattress and an anti-condensation mesh on base
- Equipped with roof racks which can carry cargo on top
- Spacious inner size for 2 or 3 person

Materials

Cover: Aluminum Honeycomb plate

Fly: 150D rip-stop polyoxford PU coated 3000mm with full dullsilver coating UPF50+

Inner: 600D rip-stop oxford PU 2000mm

Floor: 600D polyoxford PU 3500mm

Mattress: Skin friendly thermal mattress cover with 5cm high-density foam mattress anti-condensation mattress

Frame: All Aluminum, telescopic alu. ladder with 2pcs Roof bars(options)

Specification

Size 1

Sleeping Capacity:2-3 people

Inner tent size:210x125x108 cm(82.7x49.2x42.5 in)

Closed size:144x107x29 cm(56.7x42.1x11.4 in)

Packing size:155x117x32.5 cm(61x46.1x12.8 in)

Net Weight: 55kg(121.25lbs) for tent 6kg(13.23lbs) for ladder

Gross weight: 75kg(165.35lbs)

Size 2

Sleeping Capacity:3-4 people

Inner tent size:210x182x108 cm(82.7x71.6x42.5 in)

Closed size:200x107x29 cm(78.7x42.1x11.4 in)

Packing size:211x117x32.5 cm(83.1x46.1x12.8 in)

Net Weight: 73 kg(160.94 lbs) for tent 6 kg(13.23 lbs) for ladder

Gross weight: 95 kg(209.44lbs)

Accessories

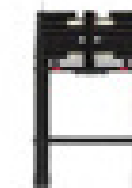



Wild Land Neo-Frontier

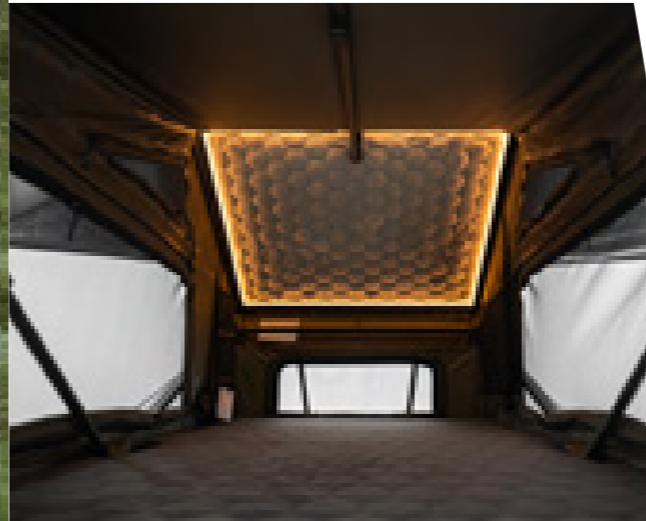

Wild Land Neo-Frontier

- Maximized interior space with a raised rear section for extra headroom.
- Quickly and easy setup with intuitive design
- Enhanced stability with a reinforced, heavy-duty frame.
- All-weather protection with durable, waterproof materials and UV resistance.
- Panoramic views through a large front door and oversized windows.
- Optional roof racks support up to 30kg(66.1lbs), providing additional storage solutions.

Specification

Inner tent size:208x130x125cm(82x51x49.2in)

Close size:152x127x30.5cm(59.8x50x12in)

Packing size : 162x137x34cm(63.8x54x13.4in)

Net Weight:76kg(167.6lbs)for the tent, 6kg(13.2lbs) for the ladder

Gross Weight: 93kg (205lbs)

Materials

Cover-Aluminum Honeycomb plate

Frame- Alu. with gas strut, alu. ladder included

Base- fiberglass honeycomb plate

Fly: 210D rip-stop oxford PU 3000mm with silver coated UPF50+

Inner tent: 190g rip- stop polycotton PU2000mm

Mattress: Skin-friendly thermal mattress cover with 5cm(2in)high density foam mattress

Accessories



Wild Land WL-Air Cruiser

Wild Land 2023 Brand New Patented Air Tube Design



Wild Land WL-Air Cruiser

- Wild Land patented design, keep you safe and comfortable as home.
- Ultra-sturdy and reliable inflatable air tube for easy set up in seconds .
- Creative built-in air pump, battery free and powered by car cigar lighter.
- Suitable for any 4x4 vehicle.
- Two big closable sky windows to enjoy sunlight and stars.
- Unique sliding curtain for sky windows.
- Large eave design for great rain protection.
- Panorama view with one big door and three large side windows.
- Compact size and light weight make the delivery simple and convenient.
- 5cm(2 in) high-density mattress with special skin-friendly thermal cover. offers soft and comfortable sleeping experience.
- Each step of the ladder with fluorescent sticker.

Materials

Fabric: 280g rip-stop polycotton PU2000mm, WR

Mattress: Skin-friendly thermal mattress cover with 5cm(2 in) high-density foam mattress

Frame: air tube (with built-in battery free air pump), Alu. telescopic ladder

Base: PP honeycomb board

Cover: heavy-duty 600D oxford with PVC coating, PU5000mm, WR

Specification

Capacity: 2 persons

Tent size: 205×132×136cm (80.7×52×53.5 in)

Close size: 139×98×28cm (54.7×38.6×11 in)

Packing size: 145.5×104×30.5cm (57.3×40.9×12in)

Accessories





Wild Land Lite Cruiser 120XL Pro

Net Weight:43KG



Wild Land Lite Cruiser 120XL Pro

- Entry level roof tent for any 4x4 vehicle, great choice for sedan.
- Light weight for easy carry and install
- Compact pack size to save roof space
- Extended inner tent for more sleeping space
- Big windows on both sides and back wall keep good ventilation and avoid mosquito in.
- Each tent comes with an air pillow and detachable dimmable LED strip inside

Specification

Inner tent size: 230×122×100cm(90.6×48.1×39.4 in)

Close size: 127×119×33cm (50×46.9×13in)

Packing size: 137×130×37cm(53.9×51.2×14.6in)

Net Weight: 43kgs(94.8lbs)(include ladder)

Gross Weight: 52.5kg (115.5lbs)

Materials

Fly: 210D rip-stop oxford PU3000mm with silver coating, UPF50+

Inner: durable 600D rip-stop oxford, PU2000mm

Floor: 210D oxford, Pu2000mm

Cover: durable 600D oxford with PVC coating, PU5000mm

Mattress: 3cm (1.2in) high-density mattress with skin-friendly thermal cover

Frame: Aluminum, Telescopic alu. ladder

Accessories



Wild Land Voyager Pro

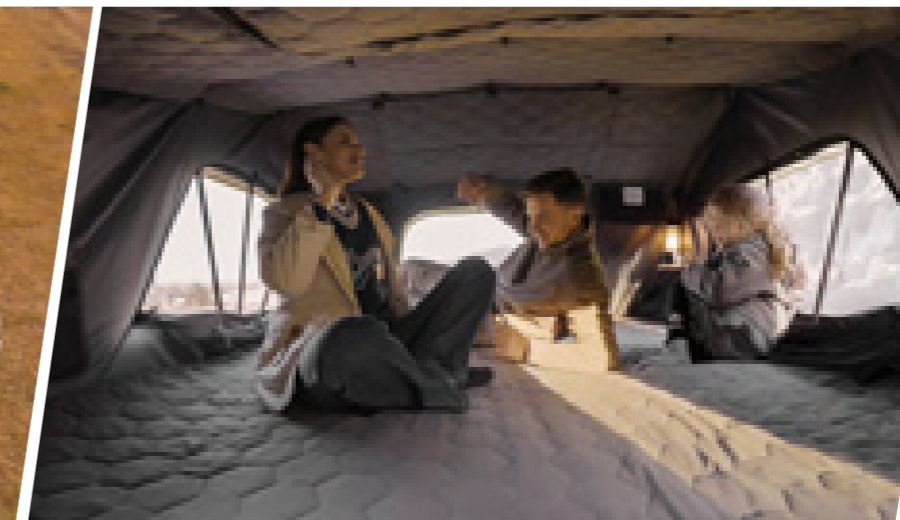

Wild Land Voyager Pro

- With Wild Land patented mechanism.
- Patented WL-tech fabric with excellent air permeability, moisture permeability and waterproofing.
- Special thermal fabric for roof to avoid condensation.
- Hard Shell design to reduce wind resistance and lower noise when driving.
- Large eave and full outer fly for great rain protection.
- 5 cm(2 in) high-density mattress with special skin-friendly thermal cover.
- With sewn-in dimmable LED strip inside the roof tent.
- Roomy space upgrade for 5 persons family camping.

Materials

Fly: Patented WL-tech fabric PU5000-8000mm

Inner: Durable 300D poly oxford PU coated

Inner Roof : Special thermal fabric (200g/m²).

Floor: 210D polyoxford Pu3000mm

Mattress: Skin-friendly thermal mattress cover with 5 cm(2 in) high-density foam mattress

Frame: Aluminum, Telescopic Alu. Ladder

Accessories



Specification

Size 1

Inner tent size: 230×200×108 cm (90.6×78.7×42.5 in)

Closed size: 214×124×27 cm (84.3×49.6×10.6 in)

Packing size: 225×134×32 cm(88.6×52.8×12.6 in)

Net weight: 66 kg(145.5 lbs) for tent,6 kg(13.2 lbs) for ladder

Gross weight: 88 kg(194 lbs)

Capacity: 5 persons

Size 2

Inner tent size:230×160×108 cm (90.6×63×42.5 in)

Closed size:174×126×27 cm (68.5×49.6×10.6 in)

Packing size:185×132×32 cm (72.8×52×12.6in)

Net weight: 55 kg(121.3 lbs) for tent,6 kg(13.2 lbs) for ladder

Gross weight: 71 kg (156.5 lbs)

Designed based on real user feedback
 — built for family adventures, including your pets
 — with more room and better sleep wherever you go



2026 NEW

Wild Land Desert Cruiser Family

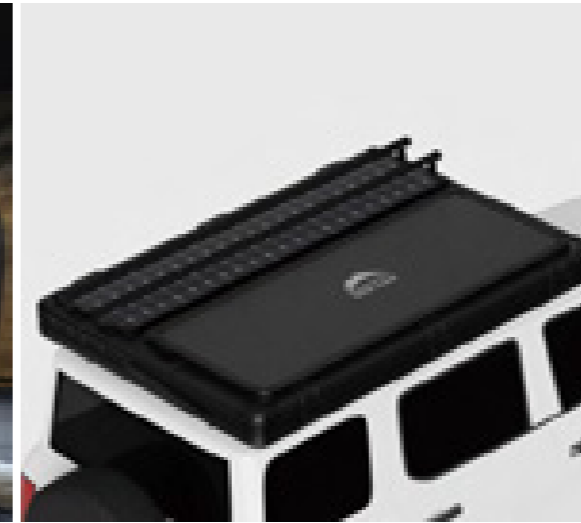

Wild Land Desert Cruiser Family

- Fits most 4x4 vehicle, with extra room for gear, pets or kids
- With Wild Land Patented Hydraulic cylinder mechanism
- Built-in LED light strip for added convenience.
- Black-out flysheet with Silver coating and UPF 50+, offering excellent sun and weather protection
- 7 cm high-density foam mattress with insulated cover for superior comfort.
- Telescopic aluminum alloy ladder is removable and endures 150kg

Materials

Cover: Aluminum honeycomb plate

Plate: Aluminum Frame

Fly: 210D rip-stop Poly oxford PU 3000mm with silver coating

Inner: 190G Poly cotton with PU 2000mm

Floor: 600D Poly oxford PVC PU 5000mm

Mattress: 7 cm high-density foam + insulated cotton cover + 7 mm PP board

Frame: Full Aluminum structure, gas strut-assisted mechanism, telescopic alu. ladder

Specification

Inner tent size: 202×130×130cm (79.5×51.2×51.2 in)

Extra room size: 170×70×68cm (66.9×27.6×26.8 in)

Closed size: 220×149×24cm (86.6×58.7×9.4 in)

Packing size: 220×148×23.8cm (86.6×58.3×9.4 in) (included ladder)

Net weight: 94kg (207 lbs) for tent, 6kg (13 lbs) for ladder

Gross weight: 114kg (251 lbs))

Accessories

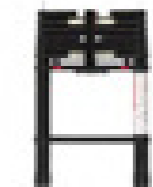

Wild Land Desert Cruiser V2 130

2026 NEW



Wild Land Desert Cruiser V2 130

2026 NEW – A refined Desert Cruiser upgrade, redefining comfort for your sleep outdoors.

- With Wild Land patented Hydraulic cylinder mechanism, quickly set up and fold down.
- With hard shell streamline design, can bear 30kgs(66 lbs) cargo on top.
- Spacious interior for 2–3 people, designed to comfortably accommodate bedding even when closed.
- Built-in power socket for camping lights, fans and other electronic devices, perfect for camping adventures.
- Equipped dimmable & mosquito-repellent LED strip, mountable on 3 interior walls.
- 7cm high density foam mattress with insulated cotton cover & 7mm PP corrugated sheet
- Telescopic aluminum ladder is removable and endures 150kgs(330.7 lbs).
- Optional roof racks support up to 30kg(66 lbs), providing additional storage options or solar panels

Materials

- Cover: Aluminum Honeycomb
- Base: Aluminum frame with gas strut, telescopic alu ladder
- Fly: 210D rip-stop polyoxford PU coated 3000mm with silver coating, UPF50+
- Inner: 190g rip-stop polycotton PU 2000mm
- Floor: 600D polyoxford with PVC coating, PU 5000mm
- Mattress: High-density mattress with skin-friendly thermal cover

Specification

- Inner tent size: 200×130×125cm (78.7×51.2×49.2in)
- Closed tent size: 220×148×20cm(86.6×58.3×7.9 in)
- Packing size: 227×159×23.5cm (89.4×62.6×9.3in)
- Net weight: 70kg (154.3 lbs) for tent, 6kg (13.2 lbs) for ladder
- Gross weight: 89kg (196.2 lbs)

Accessories

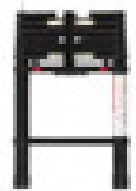

Wild Land Rock Cruiser Pro

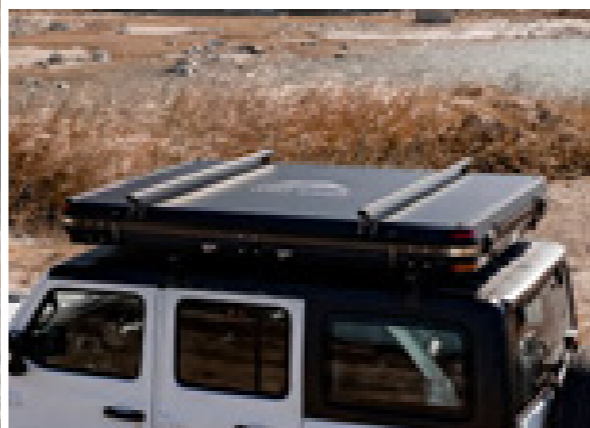

Wild Land Rock Cruiser Pro

- With Wild Land patented Hydraulic cylinder mechanism.
- Quickly set up and fold down by simple steps.
- With hard shell streamline design on both top and bottom, it is one of the thinnest roof tents in the world.
- When it is closed, the thickness is only 25 cm(9.9 in),it will improve wind resistance and minimize wind noise.
- Roomy space for two or three persons.
- 5 cm(2 in) high-density mattress helps the roof tent comfortable.
- Suitable for any 4x4 vehicle.
- One shoe pocket on each side of the front door
- Telescopic aluminum alloy ladder is removable and endures 150kgs(330.7 lbs).
- With detachable dimmable Led strip inside the roof tent.

Materials

Cover: Aluminum Honeycomb

Base: Aluminum frame

Wall:190G rip-stop polycotton PU 2000mm

Floor:210D polyoxford PU 2000mm

Matterss: 5cm high-density Foam + 4cm EPE

Frame: Wild Land patented hydraulic cylinder mechanism, all Alu.

Specification

Capacity: 2-3 persons

Inner tent size: 205x140x102 cm(80.7x55.1x40.2 in)

Close tent size: 220x155x25cm(86.6x61.1x9.8 in)

Packing size: 229x159x28 cm(90.2x62.6x11 in)

Net weight:75kg/165lbs for tent

(excluding ladder sleeping bag 1.6kg ,

Portable Lounge 1.5kg air pillow 0.35kg)

Gross weight: 94kg/207.2lbs

Accessories



Roof bar included



Wild Land Pathfinder II Pro

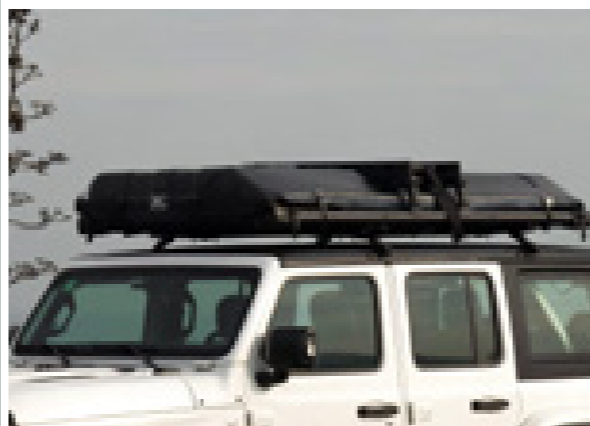

Wild Land Pathfinder II Pro

- With Wild Land new remote control mechanism.
- Quickly set up and fold down the tent by pushing the button.
- 4 pcs solar panels on the hard top roof to provide energy for tent motor, light and charge of mobile phone etc.
- With detachable dimmable LED light strip inside the roof tent.
- Two spare poles under the tent for emergency situations like no electricity, broken pushing rod, etc.
- Extended hard top roof for better rain and sun protection.
- Roomy space for two persons.
- Two double-layer windows and one big double-layer door, keeping good ventilation and protecting from insects.
- Alu. alloy ladder is fixed with frame and endures 150 kgs(330.7 lbs).
- Suitable for any 4x4 vehicle.
- Top of inner tent has a mesh window with curtain to avoid moisture condensed into dew.
- 5 cm(2 in) high density mattress with skin-friendly cover offers soft and comfortable sleeping experience.
- Two big shoe pockets on both sides of front door.
- Equipped Led Solar lamp could be mounted on the tent.

Specification

Capacity: 2 persons

Inner tent size: 205×120×100cm(80.7×47.2×39.4 in)

Packing size: 232×144×36cm(91.3×56.7×14.3 in)

Net weight: 63kg(138.9lbs) Gross weight: 77 kg(169.8 lbs)

Materials

Fly: 210D rip-stop polyoxford PU3000mm with silver coating, UPF 50+

Thermal fabric: 190G polycotton PU 2000mm

Floor: 210D polyoxford PU 2000mm

Frame: Wild Land patented automatic frame

Cover: Polymer Composites ABS

Solar panel: 125 monocrystalline silicon piece

Technology: Wireless remote control

Accessories



Wild Land Wild Cruiser Pro

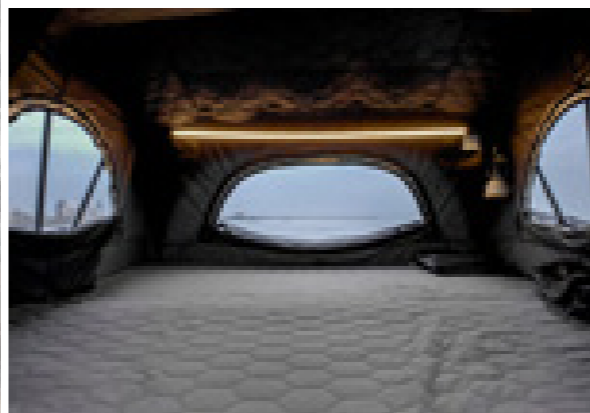

Wild Land Wild Cruiser Pro

- Suitable for any 4x4 vehicle.
- Quickly set up and fold down the tent by simple steps.
- Roomy space for 4-6 persons.
- Two big side windows and a rear window keep good ventilation and avoid mosquito in.
- Large eave for good rain protection.
- 5 cm(2 in) high density mattress provides comfortable sleep experience.
- Two big shoe pockets on both sides of front door.
- Telescopic aluminum alloy ladder is connected and endures 150 kgs(330.7 lbs).
- Size 2 version has two adjustable aluminum supporting poles to keep the roof tent more stable.

Materials

Fly: 210D rip-stop oxford PU3000mm with sliver coating, UPF50+

Inner: 190G rip-stop polycotton Pu2000mm

Floor: 210D polyoxford PU2000mm

Cover: Durable 600D oxford with PVC coating, PU5000mm

Frame: Aluminum, Telescopic Alu. Ladder

Specification

Size 1

Inner tent size: 230×160×115 cm(90.6×63×45.3 in)

Close tent size: 168×124×33 cm(66.1×48.8×13 in)

Packing size: 177×129×37cm (70×50.8×14.6 in)

Net weight: 48 kg(105.8lbs)

Gross weight: 60 kg(132.3 lbs)

Size 2

Inner tent size: 250×206×115cm(98.4×81.1×45.3in)

Close tent size: 217×137×40cm(85.4×53.9×15.8in)

Packing size: 227×145×40 cm(89.4×57.1×15.8 in)

Net weight: 77.5 kg (170.9 lbs)

Gross weight: 92.5 kg(203.9 lbs)

Accessories



+



+



Wild Land Litestri

2026 NEW

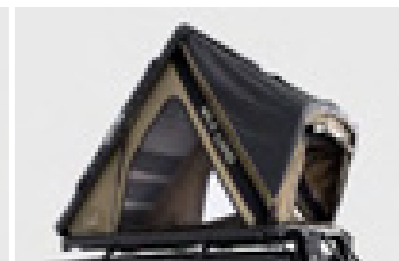

Wild Land Litestri

Engineered to deliver the durability of a traditional rooftop tent with a noticeably slimmer and lighter build, this triangular lightweight rooftop tent provides excellent stability while keeping overall weight to a minimum, the gas-strut allows for quick setup and effortless pack-down, making it ideal for both spontaneous overnight trips and extended journeys.

- **Ultra-Slim Profile:** Features an ultra-slim height for a clean, streamlined appearance.
- **Ultra-Lightweight:** Built with an ultralight structure, weighing only 68kg/150lbs with Optional 300W Solar Panel
- **Easy Installation:** light enough for quick installation, even on vehicles with lower roof-load limits.
- **Universal Vehicle Compatibility:** Works with sedans, hatchbacks, SUVs, CUVS, vans, and pickups. Compatible with all standard roof-rack systems
- **Convenient and self-powered:** The optional 300W solar panel on the roof provides convenient and reliable off-grid power wherever you go.

Accessories



Materials

Top Shell: Convenient and self-powered: The optional 300W solar panel on the roof provides convenient and reliable off-grid power wherever you go.

Fly: 210D rip-stop polyoxford PU 3000mm with silver blockout coating UPF 50+

Inner: 190g rip-stop polycotton, PU 2000mm

Floor: 600D polyoxford PU 5000mm

Mattress: 6cm high density foam mattress with insulated cotton cover + 7mm PP sheet

Frame: Aluminum, gas strut-assisted mechanism, telescopic alu ladder

Specification

Capacity: 2 persons

inner tent size: 205×130×145 cm(80.7×51×57 in)

Closed size: 216×137×21 cm(85.04×53.94×8.27 in)

Packing size: 226×147×25 cm(89.0×57.9×9.84 in) for the tent

48×9×85.5 cm(18.90×3.54×33.66 in) for the ladder

Net weight: 61 kg(134 lbs) for the tent 6kg(13.23 lbs) for ladder

Gross weight: 77kg(170 lbs)

Wild Land Bush Cruiser V2 Pro

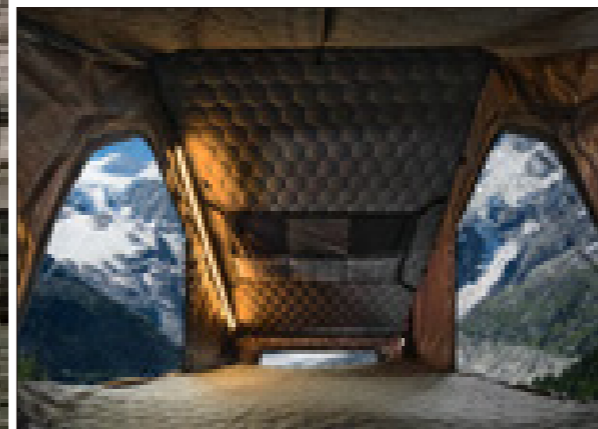

Wild Land Bush Cruiser V2 Pro

- Elevated tail to provide more inner space.
- Wild Land patent gas strut mechanism, easy and quick operation in minutes.
- One of thinnest hard shell tents on the market.
- Two detachable roof bars can bear 30kg (66 lbs) cargo and gears on top.
- Three big entrances as door and windows for easy access and good ventilation.
- Suitable for any 4x4 vehicle.

Materials

Fly: 210D rip-stop oxford PU3000mm with full dull silver coating, UPF50+
 Inner: 600D rip-stop oxford, PU2000mm
 Floor: 600D oxford, PU2000mm
 Frame: Aluminum honeycomb shell & alu. bottom frame, telescopic alu. ladder

Specification

Bush Cruiser 120 V2 Pro

Inner tent size: 205×120×125cm(80.7×47.2×49.2in)
 Closed tent size :220x143x18cm(86.61×56.30×7.09in)
 Packing size :230*140*22cm(90.55×55.12×8.66in)
 Net weight :71kg(156.53 lbs)for the tent,5.9kg(13lbs)for ladder and mounts
 Gross weight :83kg(182.98 lbs)

Bush Cruiser 140 V2 Pro

Inner tent size: 205×140×125cm(80.7×55.1×49.2in)
 Close tent size: 220x133x18cm(86.61×52.36×7.09in)
 Packing size: 230x160x22cm(90.55×62.99×8.66in)
 Net weight :79kg(174.16 lbs)for the tent,5.9kg(lbs)for ladder and mounts
 Gross weight :91kg(200.62lbs)

Accessories



Roof bar included



Wild Land Detachable Thermal Liner

- The Tri-Layer insulated detachable thermal inner tent makes a great addition to Wild Land roof tent for extremely cold weather conditions.
- Easy attachment through hooks & loops pre-sewn to all Wild Land roof tents.
- Several sizes available, fits to different models of Wild Land roof tents.

Materials: 190T tri-layer fabric, with 90G insulation fabric in between

Each packed into a master carton

Net weight: 2-2.6 kg(4.4-5.7 lbs) depending on models.



Wild Land Car Awning

- Mounts directly to roof bars and racks, sets up or packs away in minutes
- Retractable, quick to erect system including strong extendable aluminum legs
- Complete with fitting tools, ropes and pegs
- Provides shade on hot days or gives you cover from rain, snow and sleet
- Suitable for outdoor camping, picnics and more

Materials

Fabric: 210D rip-stop poly oxford PU coated 800mm with silver coating, UPF50+

Pole: Aluminum pole

Specification

Size S

Open size: 250×200×200cm(98.4×78.7×78.7 in)

Packing size: 20.5×16×229.5cm(8.1×6.3×90.4 in)

Net weight: 16.5kg(32.4lbs)

Gross weight: 18kg (39.7lbs)

Size L

Open size: 250×250×200cm(98.4×98.4×78.7 in)

Packing size: 16x21x262cm(6.3x8.3x103.1in)

Net weight: 19.5 kg(43lbs)

Gross weight: 21kg(46.3lbs)



Wild Land Car Awning LW



Wild Land Car Awning LW

- Ultra-compact packing size and lightweight design with minimal wind resistance.
- Easily mounts to SUV's, cars, trucks, and most other vehicles.
- Perfect for camping, picnics, road trips, and all kinds of outdoor adventures.
- Designed with optional wall panels to turn the shelter into a complete camping room.

Materials
 Fabric: 210D rip-stop oxford, PU 800mm with silver coating, UPF50+
 Cover: durable 600D oxford with PVC coating PU5000mm
 Pole: Aluminum pole, mounting kits included

Specification
 Open size: 228x200cm(89.8x78.7in)
 Close size: 207x11.5x7cm(81.5x4.5x2.8 in)
 Packing size: 15x10x217cm(5.9x3.9x85.4 in)
 Net weight: 9.4kg (20.7lbs)without wall panels
 Gross weight :11.5kg(25.4lbs)

Wall panels&Stay poles:
 Fabric: 210D rip-stop oxford, PU 800mm with silver coating, UPF50+
 Stay poles:Aluminum pole
 Packing size: 15x15x127cm(5.9x5.9x50 in)
 Net weight: 4.4kg (9.7lbs)
 Gross weight :5.8kg(12.8lbs)



Wild Land Annex

- Combine with roof tent eave to provide large living room for outdoor camping
- Easy set up in seconds
- Three doors for easy entrance
- Two telescopic alum. Poles on doors to provide extra awning space
- Fit vehicle height from 170-225 cm(66.9-88.5 in)
- Universal design
- Full seam tape for good water proof

Materials: 210D rip-stop polyoxford, PU3000mm,silver coating, UPF 50+

Pole: fiberglass pole, alum. Telescopic poles

Open dims: L305×W365×H240cm(L120.1×W143.7×H94.5 in)

Packing size: 127×21×21 cm(50×8.3×8.3 in)

Net weight: 11.5kg(25.4 lbs)

Wild Land Universal Tarp

- Universal design
- Combine with several styles of Wild Land roof tents perfectly to provide extra living space for outdoor camping
- Could be also used as vehicle awning without roof tent

Materials: 210D rip-stop oxford PU 800mm with sliver coating, UPF50+

Pole: Telescopic alum. Poles

Open dims: L295×W528×H190cm(L116.1×W207.9×H74.8 in)

Packing size:110x15x15cm(43.3x5.9x5.9 in)

Net weight: 5.1kg(11.2lbs)

Wild Land Universal Connector



Wild Land Universal Connector

- Universal design
- Combine with roof tent eave to provide large living room for outdoor camping
- Can be used as car rear tent , RV connector and tarp freely
- Can be connected with Wild Land instant screen house to have more space
- Adjustable height and suitable to a variety of cars

Materials

Wall : 210D rip-stop poly-oxford PU coated 3000mm with silver coating

Pole: Dia.25mm telescopic Alu. Pole

Specification

Open size: 680×298×196cm (267.7×117.3×77.2 in)

Packing size: 15x15x114cm(5.9x5.9x44.9in)

Net weight:5.95kg(13.1lbs)

Gross weight: 6.6kg(14.6lbs)



Wild Land 270° Car Awning



Wild Land 270° Car Awning

- Provides excellent shade (11.5m²/123.78 ft²) and weather protection for the side and rear of your vehicle.
- Ideal option to provide cover for both short and longer camping trips.
- With fittings for easy mount, set up in minutes.
- Come with four height-adjustable poles, it can provide better sunshade and waterproof experience.

both Materials
 Fabric: 210D rip-stop oxford with silver coating, PU3000mm, UPF50+ W/R
 Poles: Aluminum frame with strong hardware joints, 4pcs corrosion resistant fittings and Twist Lock Alu. poles
 Cover: Durable 600D oxford with PVC coating, PU5000mm
 Mounting kits included

Specification
 Open size: 460×300×200 cm(181.1×118.1×78.7 in)
 Packing size: 250×21×16.5 cm(98.4×8.3×6.5in)
 Net Weight:20.5kgs(45.2lbs)
 Gross Weight : 22kg(45.2lbs)

Wild Land U Bracket Kit

- Designed to allow you to add car awning or other overland accessories directly to Wild Land hard shell roof tent with side channels (Desert Cruiser, Rock Cruiser, Bush Cruiser etc.)



Wild Land RTT Mounting Kit

- Wild Land standard tool free mounting kits , the perfect solution to replace, upgrade or secure your tent to crossbars.
- All Wild Land roof tent models fit.

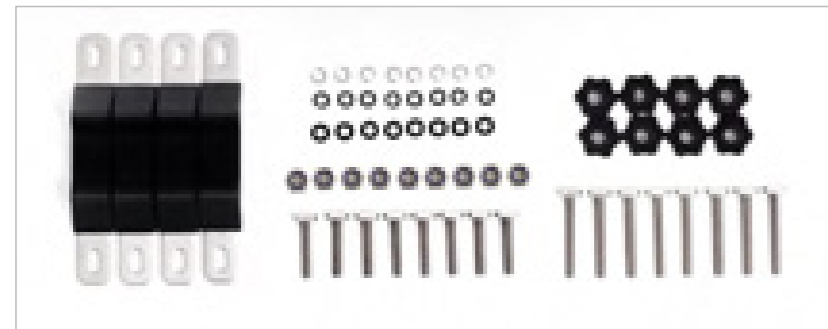

Wild Land Anti-Thief Lock System

- Secure your tent with Wild Land's security nut set.
- 2 Nuts secure 1 mounting position, and comes with 2 unique security keys.
- Fits standard M8 bolts.

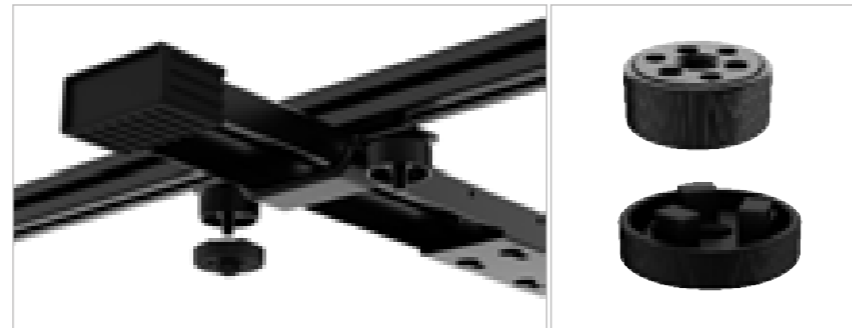

Wild Land Anti-condensation Mat

- 3D breathable mesh mat under the mattress to upgrade the sleeping comfort and can further assist with condensation.

Specification

3 sizes available:

Size 120 cm(47.2 in) for 120cm width Wild Land roof tents

Size 140 cm(55.1 in) for 140cm width Wild Land roof tents

Size 230 cm(90.6 inches) for Wild Land Voyager 230 and Wild Cruiser 250

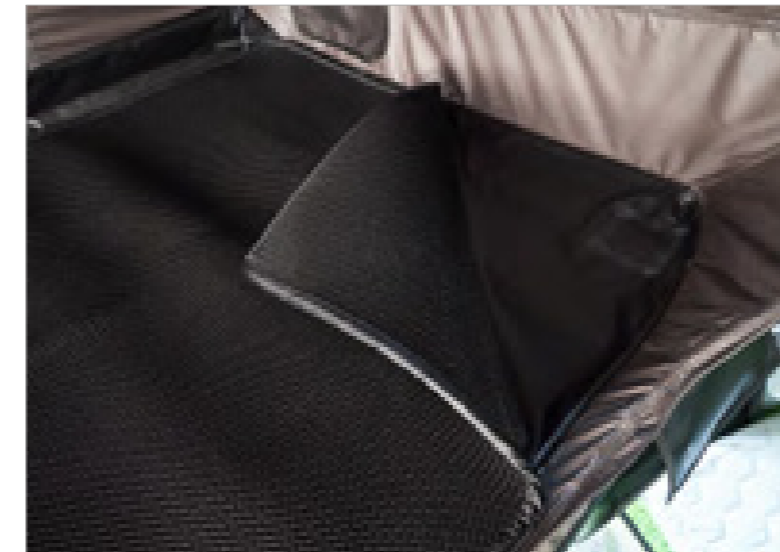

Wild Land Shoe Bags

- Features ventilated mesh bottom and back of the shoe pocket to keep shoes aired out and dry even in rainy conditions
- Fits 2 pairs of shoes or 1 pair of big boy boots.
- Hang off a roof rack with the buckled adjustable straps or into the frame on the underside of a roof top tent.
- Not just for shoes! Store toothbrush, toothpaste, shorts, pajamas, phones, keys, etc. near the Roof Top Tent doors.
- Get yourself more than one for additional storage options!

Materials

600D oxford with PVC coating , PU 5000mm





Wild Land Truck Bed Rack

- Compatible with over 75% of pickup models with 170cm/67in long crossbar.
- Two sets of installation kits included for fixing directly on the truck bed or on the other truck equipment with tracks.
- Total load capacity of 300kg/660lbs.
- Dual rust-resistant coating, soft material wrapping on contact surfaces for strong friction and easy securing.

Specifications

Packing Size: 180×28.5×19cm(70.9×11×7.5in)

Bearing Capacity: ≤300kg(660lbs)

Net Weight: 13kg(28.66lbs)

Gross weight: 16kg(35.27lbs)

Accessories: wrenches x 2pcs

Materials

Crossbar: High-strength aluminum alloy crossbar (T5 hardness)

Fix Base: Iron

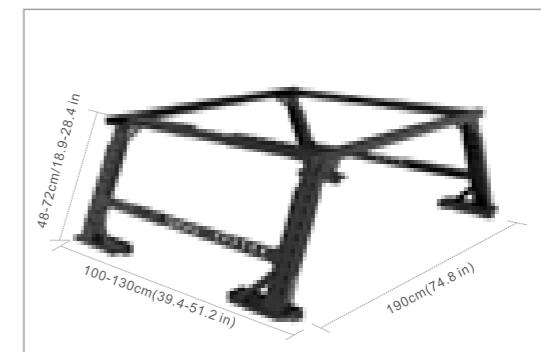
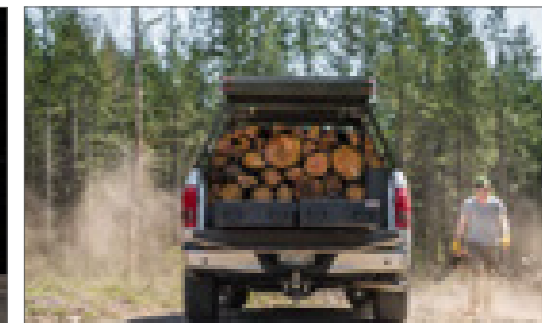

Wild Land Truck Tower System

- Versatile and modular design creating extra space for Pickups.
- Robust with strong bearing capacity (up to 250kgs/551.2 lbs) with high quality carbon steel.
- Functional even under harsh conditions and environments.
- Match perfectly with all kinds of roof top tents with pickups.
- Adjustable and compatible, fit to all kinds of pickups.
- It can be extended to 72 cm(28.4 in) high (48-72cm/18.9-28.4 in) and 130cm(51.2 in) long (100-130cm/39.4-51.2 in)

Specifications

Material: High Strength Carbon Steel

Packing size: 146×40×29cm(57.5×15.8×11.4 in)

Bearing capacity: 250 kg(551.2 lbs)

Net weight: 37kg(81.6lbs)

Gross weight: 42kg(92.6lbs)



Horizontal Detachable Wild Land Roof Rack System 2.0

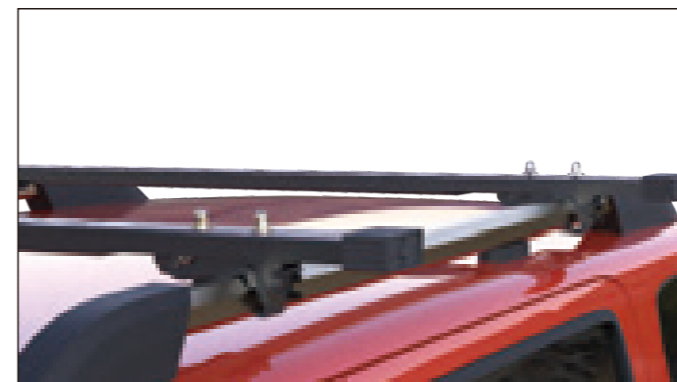

Wild Land Roof Rack System

- High Strength, strong load-bearing capacity, and corrosion-resistant.
- Patented practical and versatile design provides additional grip for rooftop cargo.
- 4 easy-to-install and durable load carrier feet (tower) and 2 Wild Land Square Bars.
- Two optional slots, adjustable as per the thickness of the bars.
- Strict height control makes unhindered access.
- Aerodynamic design to reduce wind noise.
- Rubber coated stainless steel strap secures feet to side rail, easy and non-destructive installation.

Specifications

Size: L1466×W80×H90 mm(L57.7×W3.2×H3.5 in)

Packing size: 17×11×156 cm(6.7×4.3×61.4 in)

Bearing capacity: ≤400 kg(882 lbs) (Combined load-bearing capacity of the 2 racks)

Net weight: 10.5 kg(23.1 lbs)

Gross weight: 12.9 kg(28.7lbs)

Accessories: Wrenches×2pcs

Materials

High density carbon steel

Availability

Cars originally equipped with detachable vertical load-bearing racks. Space between the car roof and the bar should be no less than 1cm(0.4 in).

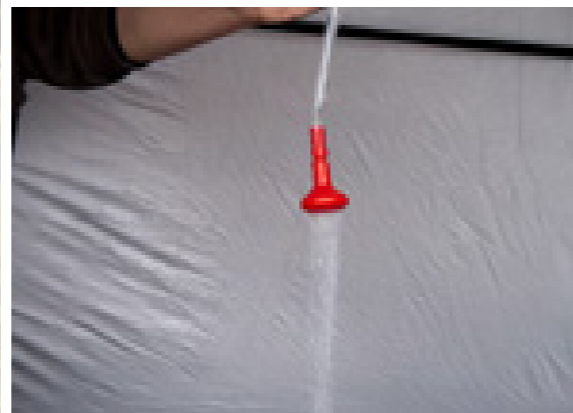

Wild Land Privacy Tent

- Set up and fold down in seconds with Wild Land Fleet Mechanism.
- Two ventilating small roof windows on top.
- D shape zip door.
- Detachable floor with mesh panel, making shower water flow out of tent quickly.
- Two pockets for storage and a string for hanging towel, etc.
- The water bag inside is able to bear 20L water for shower.

Material

Wall: 190T Polyester PU 600mm with silver coating

Floor: PE 120g/m²

Pole: Fleet Mechanism, Steel pole with special coating & Fiberglass pole on the top

Structure

Tent size: 155×155×205 cm(61×61×80.7 in)

Packing size: 107×19×19cm(42.1×7.5×7.5in)

Net weight: 6.2kg(13.7 lbs)

Gross weight: 7 kg(15.4 lbs)

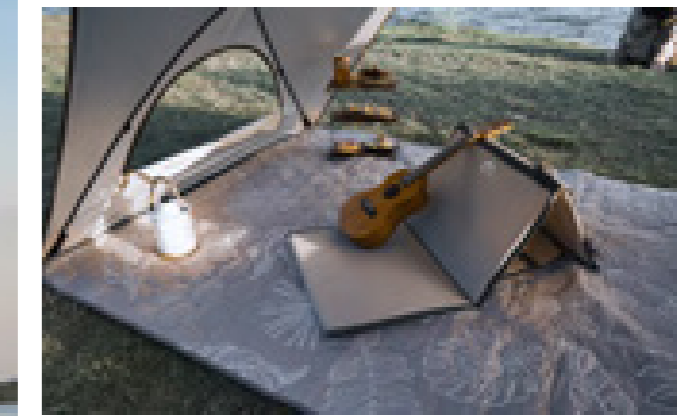

Wild Land Cambox Shade

- Extra large entrance and windows for great airflow.
- Rapid Wild Land hub frame for easy set up and pack down.
- Compact pack size for easy storage and carry.
- UPF50+ protected.

Material

Wall: 190T polyester, PU400mm, UV50+, with silver, WR with mesh

Floor: PE 120g/m²

Pole: Hub mechanism, 8.5mm fiberglass

Structure

Person: 2

Tent size: 200×150×130cm(78.7×59.1×51.2 in)

Packing size: 13.5×13.5×115cm(5.3×5.3×45.3in)

Net weight: 2.45 kg(5.4 lbs)

Gross weight: 3 kg(6.6 lbs)



Wild Land Cambox Shade Lux

- Set up and fold down in seconds with Wild Land hub mechanism.
- Stable structure, can be free-standing anywhere.
- Extra large entrance and big windows for great airflow.
- Double layer door with mesh for bugs free.
- Fabric with UPF 50+, providing excellent protection against the sun's ultraviolet rays.
- Compact pack size for easy storage and carry.

Specifications

Tent size: 200x150x130cm (78.7 x 59.1 x 51.2 in)
 Packing size: 14.5x14.5x114cm (5.7x5.7x44.9in)
 Net weight: 3.1 kg (6.8 lbs)
 Gross weight: 3.6 kg (7.9 lbs)

Materials

Wall: 190T polyester, PU400mm, UV50+, with silver, WR with mesh
 Floor: PE 120g/m²
 Pole: Hub mechanism, 8.5mm fiberglass



Wild Land Hub Screen House 400 XL

- Set up and fold down in seconds with Wild Land Hub Mechanism.
- Strong hub mechanism with puller on each side.
- Optional detachable side wall blinds.

Material

Wall: 210D polyester oxford PU coating 400 mm & mesh
 Pole: Hub mechanism, Fiberglass

Structure

Tent size: 244x244x210 cm (96.1x96.1x82.7 in)
 Packing size: 20x20x179cm (7.9x7.9x70.5in)
 Net weight: 10.6 kg (23.4 lbs)
 Gross weight: 12 kg (26.5 lbs)



Wild Land Hub Screen House 600

- Set up and fold down in seconds with Wild Land Hub Mechanism.
- Strong hub mechanism with puller on each side.
- The tent enjoys 94 total square feet of interior space with a 90" center height ,easily fits 8-10 people.
- Extra pole in both sides of the door for better support.
- Optional detachable side wall blinds.
- Hub system in each side, built-in corner grommets for staking down.

Material

Wall: 210D polyester oxford PU coating 400 mm & mesh
Pole: Hub mechanism, Fiberglass

Structure

Tent size: 366×366×218 cm(144.1×144.1×85.8 in)
Packing size:188×21×21 cm(74×8.3×8.3 in)
Net weight: 14.6 kg(32.2 lbs)
Gross weight: 16 kg(35.3 lbs)

Wild Land Hub Screen house 600 Lux

- Fast and easy operation with Wild Land strong hub mechanism.
- Utility tent with new added stove jacket in roof for outdoor cooking and heating.
- Sewn-in side wall blinds on each sides, can be rolled up for better view and ventilation.
- Extra rainy fly for water proof.
- Additional steel poles for canopy function.
- Optional detachable floor.
- Multiple tents can be connected by buckles on the side of the door.
- Combinable with Wild Land Car rear tent to offer more wonderful experience.

Materials

Wall and fly : 210D polyoxford PU800mm & mesh
Pole: Hub mechanism, fiberglass poles. Steel poles x2 for canopy

Structure

Tent size:360×311×217cm(141.7×122.4× 85.4 in)
Packing size:29×29×136cm(11.4×11.4×53.5in)
Net weight: 19 kg(41.9 lbs)
Gross weight:22 kg(48.5 lbs)

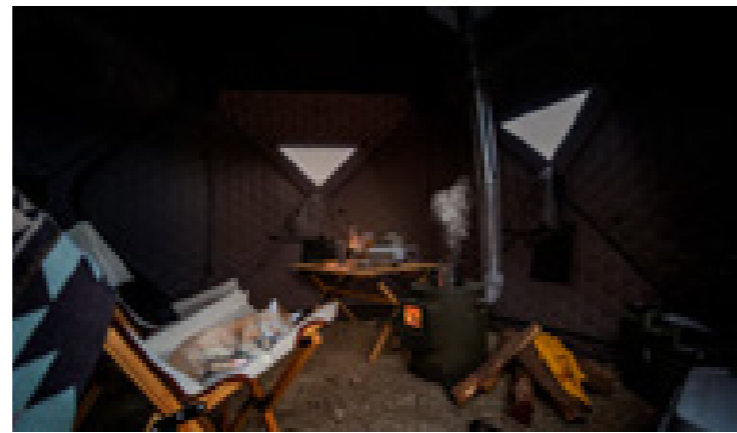

Wild Land Star hub tent

- Fast and easy operation with Wild Land strong hub mechanism.
- Perfect portable shelter for a group of buddies or a day with friends and family.
- Pentagonal ice fishing tent with enough space for 4-6 anglers.
- Full Thermal trap technology retains heat and reduces condensation.
- Built to withstand extreme weather conditions.
- Optional groundsheet and flysheet to be a winter tent.

Specification

Tent size: 277×291×207 cm(109.1×114.6× 81.5 in)
 Packing size: 32×32×159 cm(12.6×12.6×62.6 in)
 Net weight: 22.5kg(49.6 lbs)
 Gross weight: 24.5 kg(54.1 lbs)

Materials

Wall: 450D thermal fabric with black PU coating 90g/m² polyfill in between, WR, PU400mm
 Pole: hub mechanism, fiberglass pole/dia.11 mm
 Floor for Star hub tent (optional): PE 120g/m² , WR.
 Outer fly for Star hub tent(optional): 210D polyoxford PU2000mm, WR, UV50+

Wild Land MTS- Mini Table

- Super thin & Light weight.
- Easy packing and carrying.
- Full texture by bamboo and aluminium.
- Can be folded/unfolded in seconds.
- Special coating process, with anti-scratch and anti-slip function.
- Suitable for multiple place.

Materials

Alu.&Bamboo

Specification

Folded size:60×40×2.5 cm(23.6×15.7×1 in)
 Packing size:62×4.5×42 cm (24.4×1.8×16.5 in)
 Table size: 60×40×24 cm(23.6×15.7×9.4 in)
 Net weight: 2.1 kg(4.6 lbs)
 Gross weight:2.9 kg(6.4 lbs)



Wild Land MTS-X Chair

Convenient and durable, enjoy fun of DIY

- Innovative application of tenon and mortise structures to MTS-X chair.
- Quick, easy and durable.
- 100° ergonomic design of the chair back.
- Support for thighs and relaxation for calves perfectly.
- Foldable design, quick and easy operation.

Materials: Durable insulated canvas
 Frame: Aluminum and nylon

Specification
 Chair size: 67x70x86 cm(26.4x27.6x33.9 in)
 Packaging size: 70x23x23 cm(27.6x9.1x9.1 in)
 Weight: 4.9 kg(10.8 lbs)



Gobi Sand



Pine Shade Green



Black

Wild Land MTS-X Table

A brilliant creation from ancient wisdom

- Unique, stylish and durable outdoor furniture.
- Heavy duty and lightweight aluminum frame.
- Compact size for easy carry and storage.

Materials: All in alloy aluminum

Table size: 130x50x61cm(51.2x19.7x24 in)
 Packaging size: 54.5x11.5x70cm(21.5x4.5x27.6 in)
 Weight:6.3kg (13.9lbs)





Wild Land MTS-C Chair

Convenient and durable, enjoy fun of DIY

- Innovative application of tenon and mortise structures to MTS-C chair.
- Quick, easy and durable.
- 100° ergonomic design of the chair back.
- Chair at 40cm height, support for thighs and relaxation for calves perfectly.
- Foldable design, quick and easy operation.

Materials: Durable insulated canvas
 Frame: Alloy aluminum + nylon + wood

Specification
 Chair size: 53×54×84 cm(20.9×21.3×33.1 in)
 Packing size: 57.5×14×54 cm(22.6×5.5×21.3 in)
 Net Weight: 5.44 kg(12 lbs)



Wild Land MTS-C table Pro

A brilliant creation from ancient wisdom

- Innovative application of mortise and tenon structure for superior stability
- Height-adjustable legs to suit various scenarios and user preferences
- Lightweight design with compact folding for easy transport and storage
- Premium leather hand grips for a refined touch
- Quick-fold mechanism for hassle-free setup and takedown
- Crafted entirely from aluminum alloy with precision CNC machining
- Ideal for outdoor camping, indoor use, or office settings

Materials: All aluminum alloy + Nylon

Specification
 Table size: 100×65×60/80 cm(39.4×25.6×24/31.5 in)
 Packing size: 69.5×11.5×55.5cm(27.4×4.5×21.9 in)
 Weight: 6.7kg (14.8lbs)





Wild Land Picnic Pad

- Water repellent, oil repellent and stain resistant.
- Machine washable.
- Tri-layer skin friendly materials.
- The peach skin fabric pass the OEKO-TEX standard 100.
- Suitable for 4-6 persons sitting or 2-3 persons lying down.
- Could be used on beach, park, garden, inside the tent, etc.
- Compact packing size, convenient to carry.

Material: Insulated thermal fabric with 100G peach skin velvet
 Inner: 120g/m² poly-fill
 Bottom: 210D polyoxford PU400mm
 Size: 200×150×1.2 cm (78.7×59.1×0.5 in)
 Net weight: 0.98 kg (2.2 lbs)



Wild Land Collapsible Storage box

- Durable Metal & ABS Construction -Robust and wear-resistant.
- Detachable Design-Easy assembly and compact storage.
- 4 Foldable Zippered Inner Pockets -Optimal organization.
- Versatile and Eco-Friendly Bamboo Lid – can be used as a tray or cutting board.
- Portable Outer Bag with Mesh Sides - Breathable and mildew-resistant.
- 2 multi-purpose Straps-Can be used as handles or shoulder straps.
- The bamboo lid withstands up to 70kg, ensuring durability

Specifications
 Material: Aluminum + Bamboo + ABS + Nylon
 Box size: 54.5x38.5 X30.8 cm (21.46 X15.16 X12.13 in)
 Capacity: 48L
 Packing Size: 43 X15 X62cm (16.93 X5.91 X24.41 in)
 Net Weight: 8.15kg (17.97lbs)



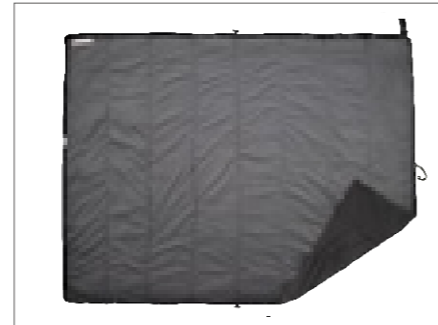

Wild Land Envelope Sleeping Bag

- The sleeping bag can be fully unzipped and used as a blanket, also can be wearable.
- Lengthwise fastening and a right-left zipper system for easy handling.
- 100% cotton of lining stand against cold completely.
- Suitable for four season camping.
- Comfortable degree 10 °C, moderate temperature 5°C , extreme temperature 0°C.

Materials

210T rip-stop polyester fabric with lining 100G/m² skin friendly fabric

Filling: Hollow cotton 300g-350g/m²

Specification

Color: Gray

Size: Sleeping bag mode: 200×75 cm(78.7×29.5 in)

Quilt mode: 200×150 cm(78.7×59.1 in)

Packing size: 25x25x38 cm(9.8x9.8x15.0 in)

Gross weight: 1.6kg(3.5 lbs)

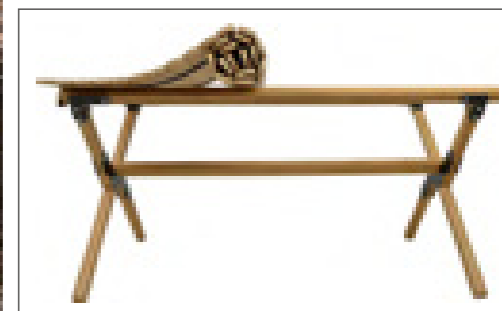

Wild Land Portable Bamboo Table

- Made of real nature bamboo, environment friendly and mildew proof.
- Foldable design for easy storage and transport.
- Stainless steel joints make it stable and durable, support up to 120kgs.
- Nature colors match most of furniture at home, outdoors, garden etc.

Materials : Real nature bamboo with stainless steel joints

Specification

Dimension: 91×60×45 cm(35.8×23.6×17.7 in)

Packing size: 93×18×18 cm(36.6×7.1×7.1 in)

Net weight: 7.9 kg(17.4 lbs)



Wild Land Canvas Lounge Pro

- Portable deck chair for convenience and extra comfort.
- Oversize storage pocket on the back to place some small items, electronic devices, etc.
- Light weight and sturdy with convenient shoulder strap.
- Close to the floor for relaxing days at the shore.
- Could be used at home, camp site, park, garden, beach, etc.
- The angle of the back can be adjustable from 0 degree to 180 degree, you can get a tent bed easily.

Materials

Fabric material: 190G polycotton
Frame: Steel

Specification

Portable Lounge size: 70×50×32 cm (27.6×19.7×12.6 in)
Packing size: 50×5.5×42 cm (19.7×2.2×16.5 in)
Weight: 1.2 kg (2.6 lbs)



Wild Land Portable Lounge

- Portable deck chair for convenience and extra comfort.
- Storage pocket for keys, phones, magazines etc.
- Light weight and sturdy with convenient shoulder strap.
- Close to the floor for relaxing days at the shore.
- Can be used at home, beach or any camping area.
- The angle of the back can be adjustable from 0 degree to 180 degree, you can get a tent bed easily.

Materials

Fabric material: 300D poly oxford

Specification

Portable Lounge size: 70×50×32 cm (27.6×19.7×12.6 in)
Packing size: 50×5.5×42 cm (19.7×2.2×16.5 in)
Weight: 1.2 kg (2.6 lbs)



Wild Land Air Pillow

- With a weight of only 333g and compact packed size, this pillow's loft and cushion will be a pleasant surprise.
- Thick luxury foam provides soft, flexible and comfortable sleeping experience.
- Traditional rectangular shape, like your favorite pillow at home.
- Inflates easily and packs down as small as a russet potato, making it ideal for backpacking and travel adventure.

Material
Elastic Fabric, Polyester Pongee, High Resilience Foam

Structure
Color: Black + Grey
Size: 46×30×11cm(18.1×11.8×4.3 in)
Net weight: Approx.331g(0.73 lbs)

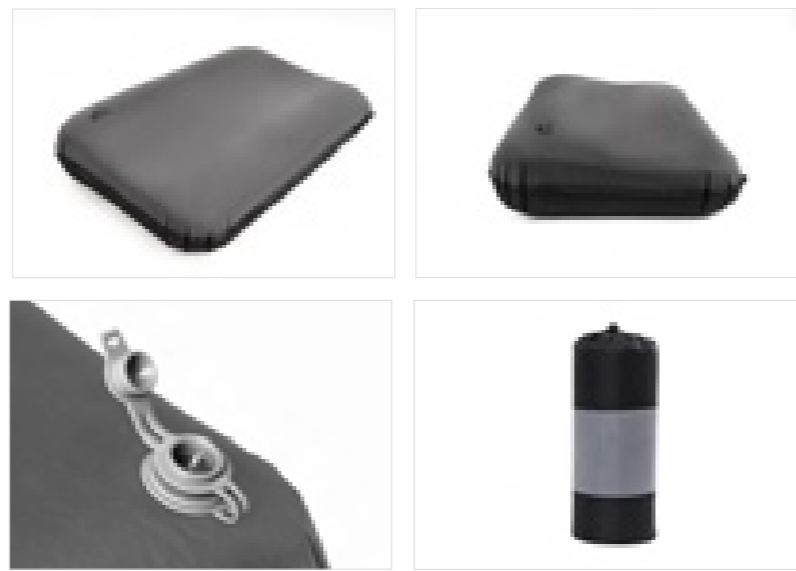

Wild Land Air Mattress

- Suitable for outdoor camping, office lunch break, family.
- Use high resilience sponge padding, comfortable and soft, intimate design.
- 360 degree rotatable valve for fast inflation/exhaust
- Inflatable design makes it easy to set up and store.
- PU sealing compound layer, reliably sealing.

Material
30D elastic fabric
75D ripstop polyester Pongee with TPU

Coating
19D high resilience foam

Specification
Size 1:
Inflated size: 115×200×10 cm(45.3×78.7×3.9 in)
Packing size: 35×35×58cm(13.8×13.8×22.8 in)
Net weight:4.9 kg(10.8 lbs)
Gross Weight: 5.9 kg(13.0 lbs)

Size 2:
Inflated size: 132×200×10 cm(52.0×78.7×3.9 in)
Packing size: 35×35×67 cm(13.8×13.8× 26.4 in)
Net weight:5.6 kg(12.4 lbs)
Gross Weight: 6.7 kg(14.8 lbs)



Wild Land Light Stand

- Adjustable height from 1.3 m(51 in) to 2.2 m(87 in).
- suitable in various scenarios.
- Various fixing methods.
- Small packaging, easy to carry.

Material
Metal+ Aluminum+ Nylon+ Fiberglass

Structure
Packaging size: 11.5×8×72 cm (4.5×3.2×28.4 in)
Net weight: 1.35 kg(3 lbs)
load-bearing: ≤1.5 kg (3.3 lbs)

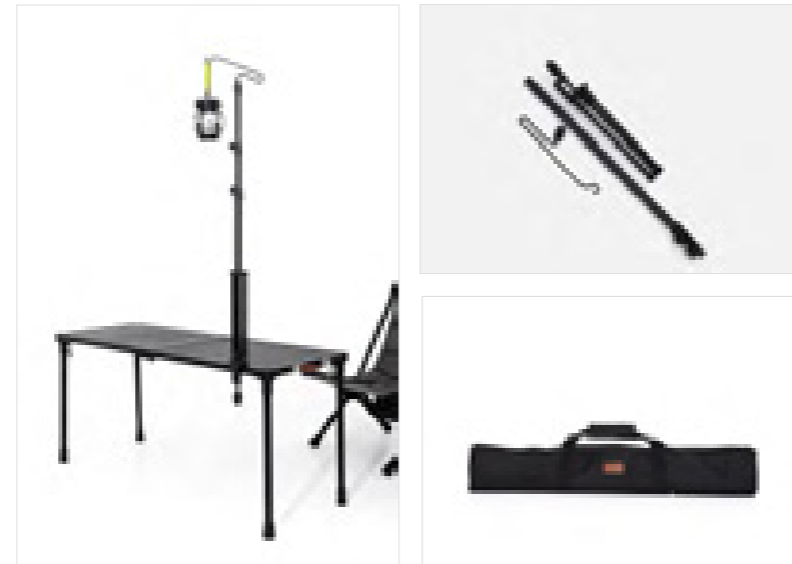

Wild Land Foldable Camping Hanging Rack

- Adjustable height 1.3 m(51 in) to 2.16 m(85 in).
- Three section storage rod provide 9 pieces hanger.
- Small footprints effectively increase utilization.
- Can be used together with our solar camping light "Galaxy".
- Detachable camping light hanger .
- Small packing carry bag, easy to carry.

Material
Steel+ Aluminum+ Nylon

Structure
Packaging Size: 13.5×13.5×84cm (5.3×5.3×33.1 lbs)
Loading-bearing: ≤ 6 kg/13 lbs
(single rod loading-bearing ≤2 kg/4.4 lbs)
N.W.: 2.6 kg(5.7 lbs)



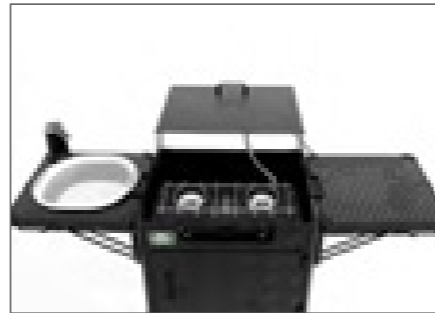

Wild Land Integrated Kitchen Box Pro

- Wild Land's brand-new integrated kitchen box provides great convenience and more fun for camping.
- Optional stove, basin, and water pump help make your outdoor cooking easier.
- Compact size for easy storage
- Expandable and foldable within minutes.
- Double-burner equipped; fully extended height: 85 cm.

Product Dimensions
 Expanded/Setup: 126.5x92x67cm(49.8x36.2x26.4in)
 Packing Size: 67x48x57 cm(26.4x18.9x22.4in)
 Closed: 62.5x41x50cm(24.6x16.1x19.7 in)
 Net Weight (N.w.): 23 kg(50.7 lbs)
 Gross Weight (G .w.): 30 kg (66.1 lbs)



Wild Land Multi-function Outdoor Cookware

- Multifunctional for stewing, grilling and frying.
- Supported by three power sources: firewood, gas, and charcoal.
- Cast Iron material is good for health.
- Detachable structure makes it easy to clean and carry away.
- The wooden pot cover could be used as a chopping board.
- Maximum energy consumption is about 220g/h.
- Average boiling time is 3.5 minutes.
- A 450g fuel can last 150 minutes.
- The stable frame can support up to 20 kg (44.1 lbs).

Frame
 Material: 3pcs two-section metal poles, cast iron
 Color: black
 Size: 76.7×73.3cm(30×29in)(set up)
 Weight: 8 kg(17.6 lbs)

Pot
 Material: metal, cast iron
 Color: black
 Size: Dia. 28 cm(11 in)
 Weight: 7.5 kg(16.5 lbs)



Wild Land S14 String Light with speaker

Great for Party and Festival, suitable to be attached to Wild Land outdoor gears.

Wild Land S14 String Light with speaker

- Ideal for parties and festivals; perfectly compatible with Wild land outdoor gear.
- Unique hemp-rope design. Standard length is 5 m (16.4 ft) with 10 E27/E26 sockets (other lengths optional).
- Integrated S14 Bluetooth speakers bulbs for both lighting and audio.
- Multiple S14 speakers can be interconnected.
- Suitable for camping, backyard parties, patios, and more.

Whole string light

Materials: ABS+PVC+ Copper+Silicon+Hemp Rope

Rated power: 8.8W(8pcs light bulbs with 2 speakers)

Length: 5 m (16.4 ft) (other lengths optional)

IP rating: IP44

Light bulbs

Rated power: 0.35W

CCT: 2700K-6500K

Voltage: DC12V

Type: S14

Base: E27/E26

Lumen: 38 lm/pcs

Speaker

Rated power: 3W

Voltage: DC 12V

Type: S14

Base: E27/E26

Connecting Range: Speaker to Bluetooth 10M, speaker to speaker 5M.

Bluetooth Version: 5.4

Size

Inner box: 29x21x12cm (11.4x8.2x4.7in)

Net weight: 1kg (2.2lbs)

Packing size(4pcs): 44x31x26cm (17.3x12.2x10.2in)

Gross weight: 5.2kg (11.44lbs)

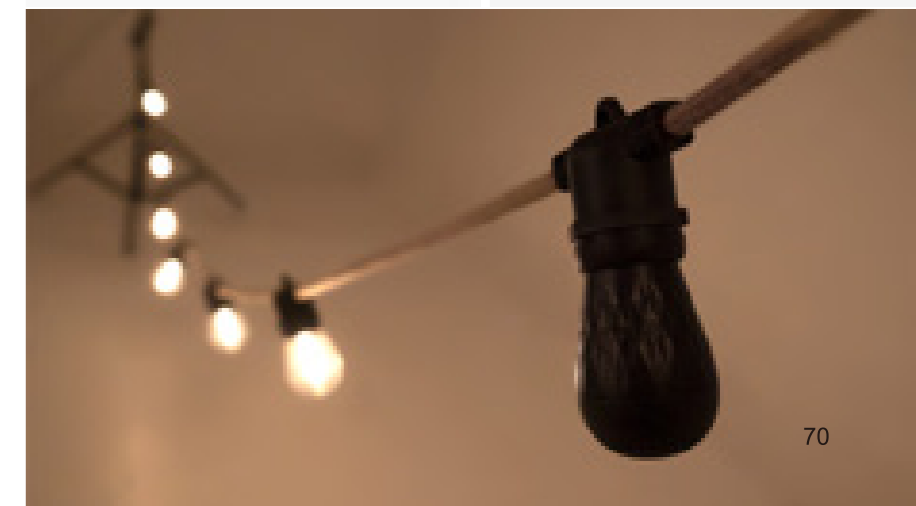
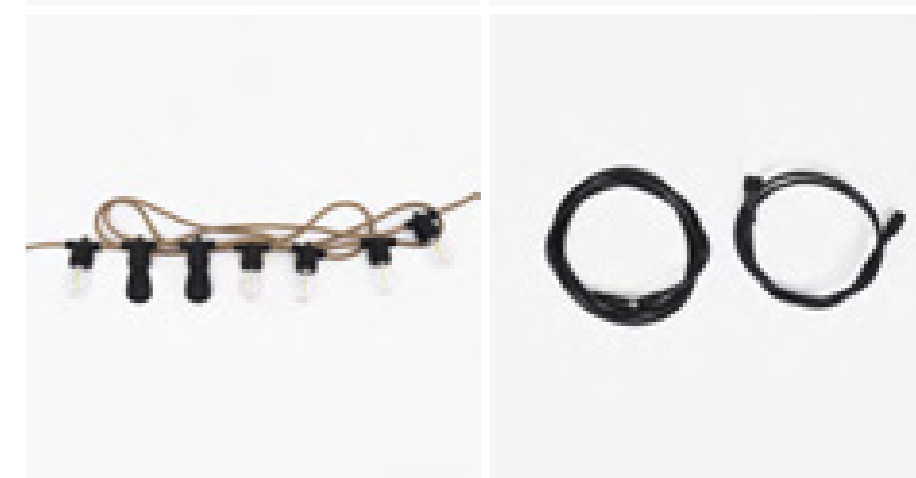



Solar



Waterproof



Lighting



Charging

wild Land Galaxy Solar Light



Main lamp

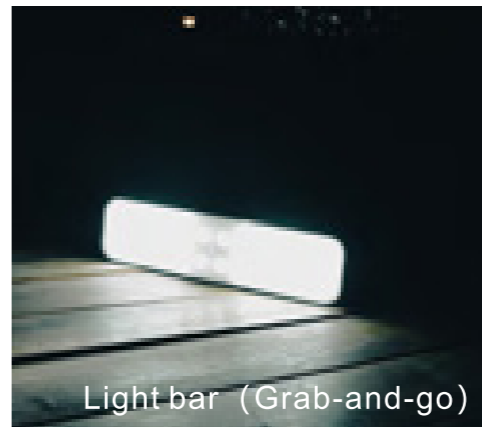

Light bar (Grab-and-go)



Tripod 1



Tripod 2

Wild Land Galaxy Solar Light

Specification

Whole lamp:

Main materials: ABS+PC+ Nylon + Silicone+ Metal (tripod)

Rated power : 26W

Lumen:380lm-3000LM

Color temperature: 6500K

Input: Type-C

Input: 5V/3A

Battery:3.7V 5000mAh/5200mAh&3600mAh lithium batteries

Charging time: 7 hours(by power charger); 32H(by solar panel)

Run Time: 3~11.5 hrs

Lifespan:20000Hours

Main lamp

Rated power : 13W

Lumen:190lm-1600lm

3 lighting modes: Low 190lm, Middle 350lm, High 1600lm/750lm(steady lumen)

Input: 5V/2A

Run time:3~11.5hrs

Battery: 3.7V 5000mAh/5200mAh lithium battery

Charging time: 4.5h

Weight: 1100g(2.43lbs)

Side lamp

Rated power : 13W

Lumen: 190lm-1400lm

5 lighting modes: Low 190lm, Middle 350lm, High 650lm, Spot light 450lm,

Full bright mode 1400lm/750lm(steady lumen)

Input/output: 5V/1A

Run time:1.5~6hrs

Charging time: >6hr

Battery: 3.7V3600mAh lithium battery

Charging time: 6H

Weight: 440g (0.97lbs)

Wild Land Trackwalker Lantern

LED Lantern

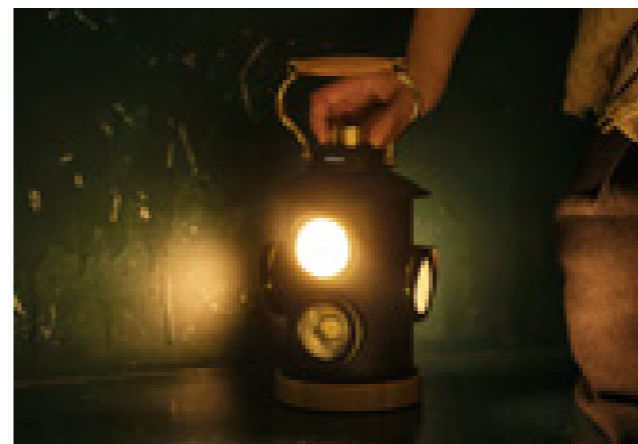
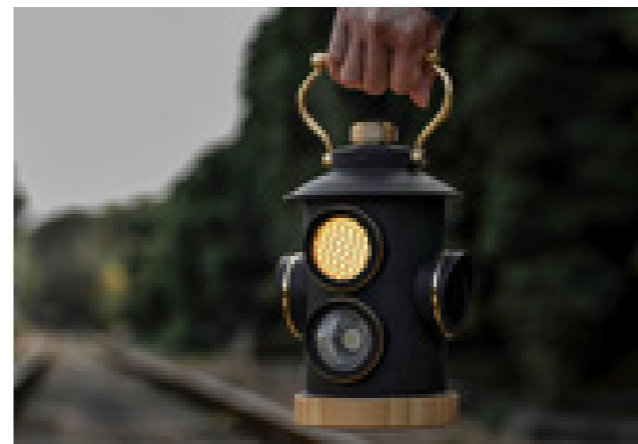

Wild Land Trackwalker Lantern

- Classical retro design, a true signature light for the Trackwalker series
- Unique combination of materials: bamboo, copper, metal, and ABS
- Built-in 5200mAh rechargeable Li-ion battery, supporting USB-C charging (DC 5V / 3A)
- Special multi-mode lighting design, integrating signal light, three reading lights, spotlight, and SOS light
- Stepless dimming with power indicator

Signal light mode

Rated Power: 6.5W
Lumen: 160lm Max
Duration: 10-60hours
CCT: 2700K

Spotlight mode

Rated power: 10.5W
CCT: 6500K
Lumen: 450lm Max
Duration: 7-50hours

Reading light*3 Plus Signal light mode

Rated power: 14.5W
CCT: 2700K
Lumen: 320lm Max
Duration: 6 hours

Whole lamp

Battery: Li-on 5200mAh 3.7V
Charging time: 2 hrs
Input: USB-C DC 5V/3A
IP rating: IPX4
Shell Materials: Bamboo + Copper + Metal + ABS
Weight: 1300g

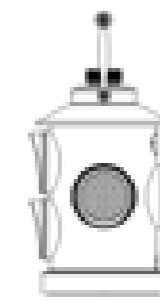
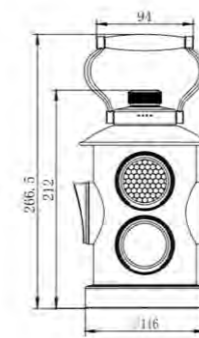

Dimmable



Wild Land Thunder Lantern

LED Lantern

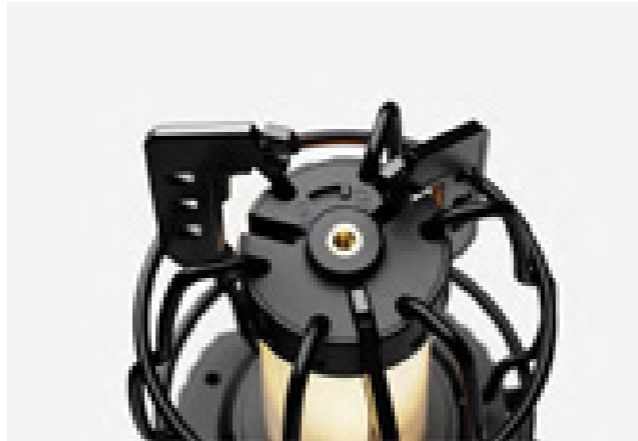

Wild Land Thunder Lantern

Inspired by the shape of a grenade, this product is designed to be durable, light, compact, and multifunctional for outdoor enthusiasts.

Material: Metal+ABS+detachable nylon handle

Rated Power: 5.5W

Lumen: 2200K:25-250lm/6500K:25-300lm

Beam angle: 360°

CCT: 2200K/6500K

Battery: Li-ion Battery

Battery capacity: 1800mAh/3600mAh/5200mAh

Charging time: 1800mAh:≥3.5H/3600mAh:≥5H/5200mAh:≥7H

Working time: 1800mAh:3.3H-20H/3600mAh:6H-40H/5200mAh:11H-60H

Working temp: 0°C~45°C

Working humidity: ≤95%

IP rating: IPX4

Input: Type-C 5V/1A

Weight: 1800mAh:365g(0.8lbs) 3600mAh:490g(1lbs) 5200mAh:490g(1lbs)

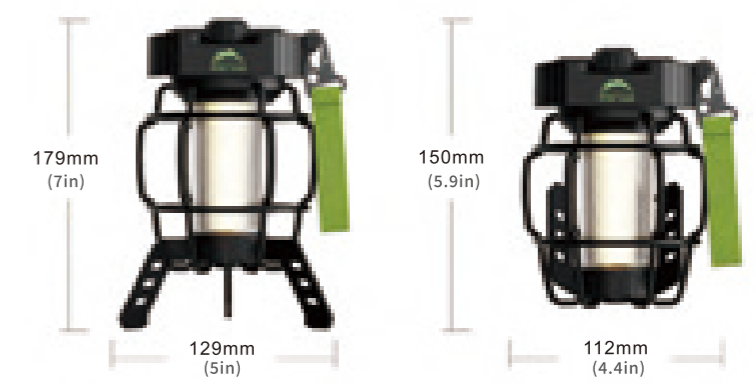

Dimmable



Wild Land Mini Lantern

LED Lantern

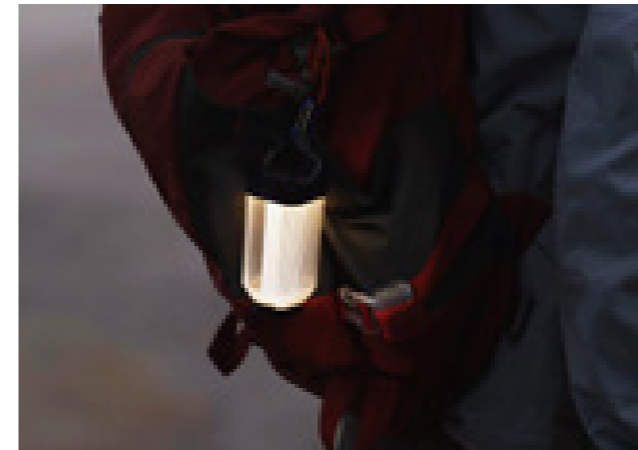

Wild Land Mini Lantern

The lantern is easy to carry; it can be placed in a pocket or hung on a backpack.

Dimmable by touch.

The lantern offers three ways of use:

- Hang with a hook
- Put it on a desk
- Mount on a tripod using the bottom threaded hole

Materials: PC + Metal + ABS

Rated Power: 2.2W

Voltage: 3.0-4.2V

Lumen: 5-160lm

Working time: 12-170H(3500mAh battery)

8.5-120H(2600mAh battery)

4.5-65H(1800mAh battery)

Charging time: ≥4.5H(3500mAh battery)

≥4H(2600mAh battery)

≥3.5H(1800mAh battery)

With battery indicator light

Input: Type-C 5V/1A

IP rating: IPX7

Dim: 4.5x4.5x10cm(1.8x1.8x3.9in)

Net Weight: 104g (0.23lbs)

Working Temperature: 0°C~45°C

Working Humidity: ≤95%



Dimmable

Wild Land Ring Lantern

LED Lantern



Wild Land Ring Lantern

Legend has it that 1600 years ago, a lady missed her sweetheart so much.

She drew rings to express her love. Her sweetheart received her letter full of rings and completely understood her yearning.

Then he wrote a poem for this ring letter: "Love is missing and there is no way to meet, so rings take its place: Single ring for me, double ring for you, triple rings so that we are together all the time."

Our Ring Lantern is like a poem—for love, for marriage, and for family.

Lighting modes: Warm light/Breathing light/Cool light/ Mixed highlight

Applications: Indoor(Hotel, Cafes & Dining room), Outdoor(Lawn, Garden & Campsite)

Materials: Plastic + Metal+Hemp Rope +Bamboo +Silicone

Power range: 0.2W-12W

Color temperature: 2200K/5700K

Lumen: 6~380LM

Beam angle: 360D

Input: Type-C 5V/1A

Battery: 3.7V Li-ion battery(18650*2)/AA battery 3pcs

Li-ion battery capacity: 5200mAh(5000mAh)/3600mAh

Working time: 5200mAh:2.5~180hrs/3600mAh:1.3~90hrs

Operating temperature: 0°C~45°C

IP rating: IPX4

Weight: 550g (1.2lbs)

Product size: 116x116x195mm(4.5x4.5x7.7in)

Working Humidity: ≤95%

Wild Land Knight SE

Aim to peace and happiness

LED Lantern



Wild Land Knight SE

- Aims for peace and happiness.
- Patented light source design with 3 lighting modes: Breathing-Twinkling - Dimming.
- With USB output, can be used as a power bank.

Materials: Plastic + metal + bamboo

Rated power: 3.2W

Dimming range: 10%~100%(0.4~3.5W)

Color temperature: 2200K

Lumens: 5~180LM

Beam angle: 360°

Input: Type-C 5V/1A

Output: 5V/1A

Product dims: 126.2x126.2x305.2mm(5x5x12in)(included handle height)

Inner box dims: 143x143x255mm(5.6x5.6x10in)

Battery: 18650 Li-ion

Battery capacity: 3600mAh

Charging time: ≥5H

Working Time: 4.8~72H

IP rating: IPX4

Net weight: 550g (1.2lbs)(included Li-ion*2)

Working Humidity: ≤95%



Breathing



Twinkle



Dimmable

Wild Land High Lumen Knight SE

LED Lantern

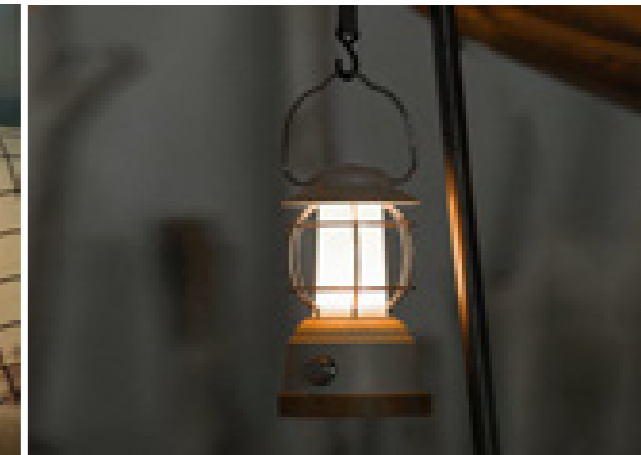

Wild Land High Lumen Knight SE

- Patented design, applicable for both indoor and outdoor use.
- Two color temperatures adjustable, with dimmable brightness.
- Quick charging function.
- Metal spherical frame, light weight and stable structure.
- Convenient hanging design, easy to carry.

Materials: plastic +metal+bamboo

Rated Power: 8W

Dimming Range: 5%~100%(6.5W-8.5W)

Color Temperature: 2200K/5700K

Lumens: 15~350LM@2200K,20-450LM@5700K

Beam Angle: 360°

Input: Type -C 5V/3A

Output: 5V/3A

Product dims: 126.2x126.2x305.2mm(5x5x12in)(included handle height)

Inner box dims: 143x143x255mm(5.6x5.6x10in)

Battery: 18650 Li-ion

Battery Capacity: 3600mAh/5200mAh/10400mAh

Charging Time: 3600mAh≥2H/5200mAh≥3H/10400mAh≥5.5H

Working Time: 3600mAh 3~150H/5200mAh 6~200H/10400mAh 8~300H

Working temp: 0°C~45°C

Working humidity: ≤95%

IP rating: IPX4

Weight: 560g(1.2lbs)(included Li-ion battery*2)



Dimmable



CANTON FAIR DESIGN AWARDS

Dimmable

Wild Land Hemp Rope Lantern

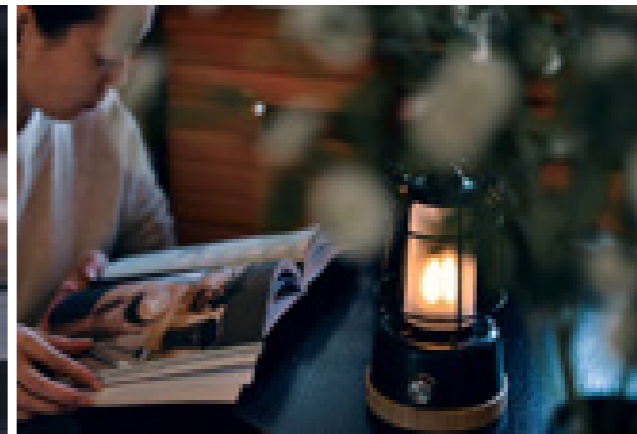

Wild Land Hemp Rope Lantern

- The lantern is featured by its unique design. It combines the hemp rope with metal and bamboo to create this retro and durable camping lantern. What's more, you can detach the hemp rope to hang the lantern onto the tree or inside the tent.

Lighting Modes: Breathing / Twinkle / Dimming

Lumens: 10-200lm

Rated power: 3.2W

Output: 5V/1A

Battery: 2pcsx2500mAh lithium batteries(18650)

Working time: 8-120hrs

Materials: Plastic+Iron+Bamboo

IP rating: IPX4

Product dims: dia.126.2x311mm(5x12.2in)(included rope height)

Inner box dims: 143x143x260mm(5.6x5.6x10.2in)

Net weight: 600g(1.3lbs) (included battery)

Working humidity: ≤95%

Working temp: 0°C~45°C

Input: Type-C 5V/1A



Breathing



Twinkle



Dimmable

Wild Land High Lumen JADE

LED Lantern



Wild Land High Lumen Jade

- Soft lamp body and uniform illumination, like a warm jade.
- Patented special light source performs 2 lighting modes.

Material: Plastic+ Hemp Rope + Bamboo

Rated Power: 8W

Lumen (lm): 30-550lm

Color temperature: 2200K

2 lighting modes: Dimmable, Breathing

IP rating: IPX4

Battery type: Li-ion(18650*2)

Battery capacity: 3.7V 3600mAh/5200mAh

Working time (H): 5200mAh: 4~72H, 3600mAh: 2~40H

Charging time: >5h

USB port: Type-C

USB input: 5V 1A

Lamp weight: 380g

Item size: 116x181mm (4.6x7.1in)

Weight: 400±10% kg(0.88bs)



Breathing



Steady on